



BAUER

FOR A GREEN WORLD



**Genuine BAUER
Simply the best**

The world's favourite industrial Q.C. coupling system

HK COUPLING – The Genuine

Unrivalled after 50 years of development



Advantages

Fast

A complete system quickly installed, even in the dark. No tools - no loose parts.

Flexibility

With up to 30° articulation on coupling joint. Suction and pressure-proof, providing excellent flexibility of installation, ideal for difficult site conditions.

Strong and durable

Produced from high-grade high-tensile steel, abrasion-resistant hot-dip galvanisation according to DIN 50976 - also stainless steel option.

Safe

Suction and pressure-proof up to 20 bar with all types of media, subject to suitable seal material options.

Heat resistance

Resists up to 110° C with special seals.

Tensile resistance

Suction and pressure-proof while subject to tensile stress.

Versatile

Suitable for handling all types of products: hot dip galvanised or stainless steel product range. Special coatings on application.

Security

With special locking pin system option.

Applications

Mining and tunneling, civil engineering projects, road construction, delivery of fresh water, waste water, and compressed air. Suction and delivery lines for site dewatering, on shore/offshore drilling, ship to ship/shore transfer.

In civil/military emergency, drinking water supply, disaster and fire control, temporary and emergency water supply lines, sewage, sludge, and waste disposal, by pass lines. Exhaust gas emission, oil industry applications. Pneumatic conveyance systems for powder and granular materials. Vacuum loading and extraction systems.

Media

Potable drinking water, waste water, compressed air, gasses and exhaust fumes, sludge, mortar, bentonite, crude oil and oil products, pneumatic loading of powder materials, and many more, subject to suitable seal options. Stainless steel range suitable for food, pharmaceutical, and chemical industries.



HKS design

Special locking pin system - absolutely necessary for pressurized media and as a protection against unintentional opening.





BAUER

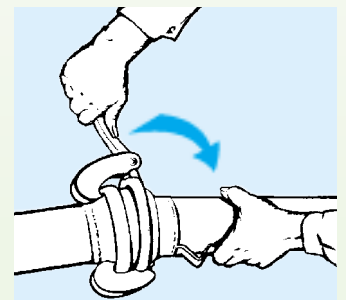
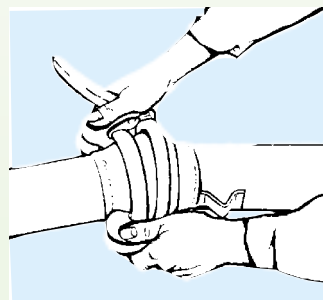
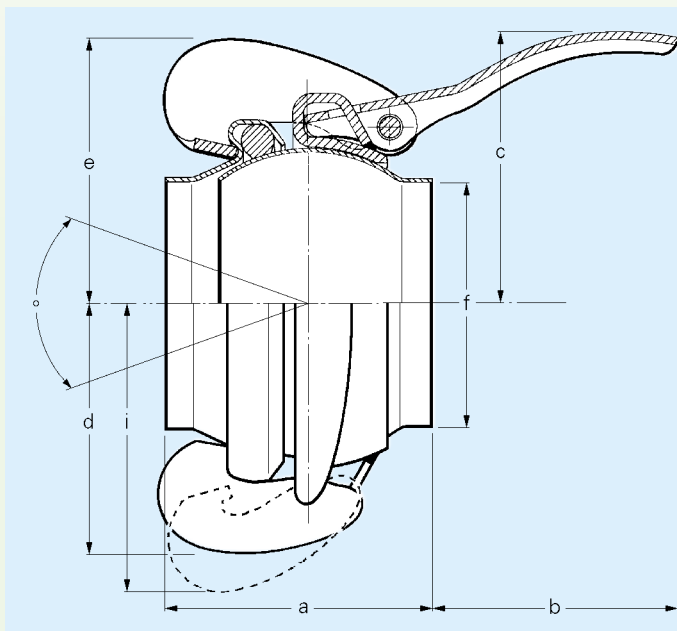

Unmatched efficiency

Genuine BAUER HK couplings are quickly and easily coupled/uncoupled with a few simple hand movements, providing great flexibility of installation – even on difficult sites – with articulation on coupling joint up to 30°.



Dimension HK	inch	a	b	c	d	e	f	°	i	PN bar
50	2	69.7	93.7	80	65	63	49	30	80	20
76	3	90.2	118.6	85	90	95	76	30	120	12
89	3 1/2	114.1	104.4	116	101	107	89	30	130	20
108	4 1/4	127.3	136	114	115	123	108	30	150	12
133	5 1/4	122.7	162.5	141	130	137	133	20	170	12
159	6 1/4	135.8	148.8	157	152	149	159	20	195	12
194	7 5/8	160.2	143.7	186	180	177	194	20	215	12*

Pipe installation system

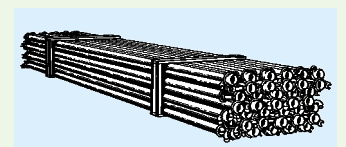
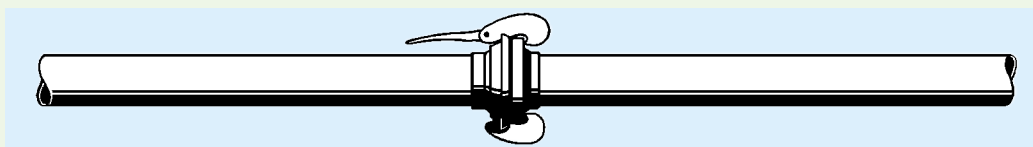

Genuine BAUER HK/HKS Quick-coupling Pipes, hot dip galvanised, standard length 6 m

Dimension HK	inch	Wall thickness mm		Weight kg/pipe		No pipes in bundle	Weight/bundle kg		per pipe		per bundle	
		HK	HKS	HK	HKS		HK	HKS	HK	HKS		
50	2	0.65	1.5	6.30	12.80	150	961	1936	101 0116	155 0116	101 0096	155 0096
76	3	0.65	1.5	10.80	19.70	74	815	1474	109 0116	156 0116	109 0096	156 0096
89	3 1/2	0.7	1.5	13.70	23.40	45	633	1069	104 0116	161 0116	104 0096	161 0096
108	4 1/4	0.85	1.5	18.60	29.10	38	723	1122	105 0116	162 0116	105 0096	162 0096
133	5 1/4	1	1.5	25.90	38.20	26	689	1009	110 0116	158 0116	110 0096	158 0096
159	6 1/4	1	2	33.90	57.20	17	592	988	107 0116	159 0116	107 0096	159 0096
194	7 5/8	1.1	2	45.30	69.40	12	560	849	108 0116	160 0116	108 0096	160 0096

HK COUPLING – The Genuine

Genuine BAUER HK/HKS Fitting Pipes, hot dip galvanised, in lengths of 1, 2 and 3 m

Dimension HK	inch	Pipe length 1 m			Pipe length 2 m		Pipe length 3 m				
		Weight kg	HK	Weight kg	HKS	Weight kg	HK	Weight kg	HKS		
50	2	1.55	101 0111	2.70	155 0111	2.60	101 0112	3.50	101 0113	6.70	155 0113
76	3	3.40	109 0111	4.70	156 0111	5.00	109 0112	6.70	109 0113	10.70	156 0113
89	3 1/2	4.15	104 0111	5.90	161 0111	6.00	104 0112	7.65	104 0113	12.70	161 0113
108	4 1/4	5.30	105 0111	7.80	162 0111	8.60	105 0112	11.40	105 0113	16.20	162 0113
133	5 1/4	9.40	110 0111	10.70	158 0111	11.70	110 0112	16.00	110 0113	21.70	158 0113
159	6 1/4	10.50	107 0111	15.30	159 0111	15.10	107 0112	19.90	107 0113	32.00	159 0113
194	7 5/8	16.70	108 0111	20.40	160 0111	22.90	108 0112	29.10	108 0113	40.20	160 0113

Genuine BAUER HK Ball S1

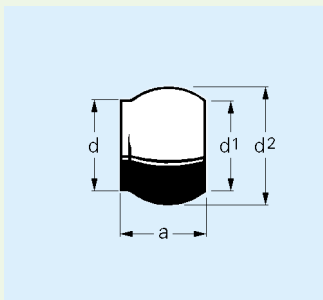

Dimension HK	inch	a	d	d ¹	d ²	Weight kg	PN bar	HK black	HK galvanised	HK stainl.steel
50	2	54	49,5	52	70	0.13	20	101 0182	101 0132	194 0182
76	3	73.5	76	78	97.5	0.26	12	109 0182	109 0132	199 0182
89	3 1/2	87	89	90	119.5	0.37	20	104 0182	104 0132	196 0182
108	4 1/4	104.5	108	111	144	0.69	12	105 0182	105 0132	195 0182
133	5 1/4	96.5	133	135	159.5	0.81	12	110 0182	110 0132	192 0182
159	6 1/4	119	159	154	179.5	1.29	12	107 0182	107 0132	197 0182
194	7 5/8	127	194	200	230	1.90	12*	108 0182	108 0132	198 0182

Genuine BAUER HK Lever Closure Ring S2

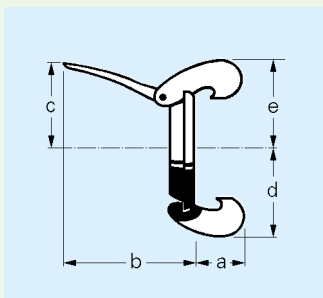

Dimension HK	inch	a	b	c	d	e	Wt. kg	PN bar	HK black	HK galvanised	HK nickeled	HKS galvanised
50	2	38	120	80	65	63	0.42	20	101 0184	101 0134	101 0124	155 0134
76	3	62	170	85	90	95	1.08	12	103 0184	103 0134	103 0124	156 0134
89	3 1/2	62	175	116	101	107	1.40	20	104 0184	104 0134	104 0124	161 0134
108	4 1/4	65	210	114	115	123	1.80	12	105 0184	105 0134	105 0124	162 0134
133	5 1/4	80	230	141	130	137	3.05	12	110 0184	110 0134	110 0124	158 0134
159	6 1/4	90	170	157	152	150	4.05	12	106 0184	106 0134	106 0124	159 0134
194	7 5/8	100	160	186	180	177	6.10	12*	108 0184	108 0134	108 0124	160 0134

Genuine BAUER HK Socket S3

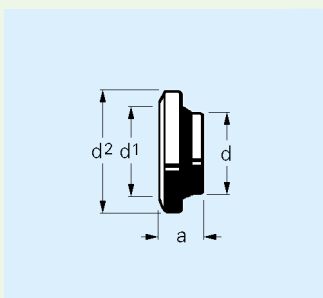

Dimension HK	inch	a	d	d ¹	d ²	Weight kg	PN bar	HK black	HK galvanised	HK stainl.steel
50	2	32	49.5	70,5	83	0.12	20	101 0183	101 0133	194 0183
76	3	36	76	100.5	116.5	0.25	12	109 0183	109 0133	199 0183
89	3 1/2	54	89	120	137	0.39	20	104 0183	104 0133	196 0183
108	4 1/4	58	108	145	167	0.64	12	105 0183	105 0133	195 0183
133	5 1/4	60	133	161	191	0.92	12	110 0183	110 0133	192 0183
159	6 1/4	50	159	180.5	212	1.16	12	107 0183	107 0133	197 0183
194	7 5/8	76	194	234	267	2.32	12*	108 0183	108 0133	198 0183



BAUER

Genuine BAUER HK Rubber Sealing Ring S4, S5

Dimension HK	inch	d	Weight kg	HK for water	HK oil-resistant	HK food grade
50	2	50	0.02	101 0140	101 0141	101 0142
76	3	76	0.05	103 0140	103 0141	103 0142
89	3 1/2	89	0.06	104 0140	104 0141	104 0142
108	4 1/4	108	0.09	105 0140	105 0141	105 0142
133	5 1/4	133	0.15	110 0140	110 0141	110 0142
159	6 1/4	159	0.21	107 0140	107 0141	107 0142
194	7 5/8	194	0.25	108 0140	108 0141	108 0142

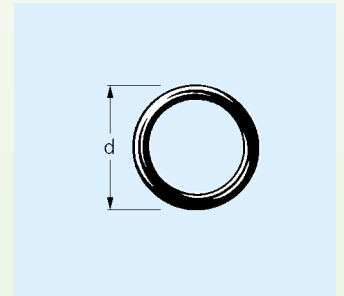

Special seal material options available on request!

Genuine BAUER HK End Cap S8

Dimension HK	inch	a	d ¹	d ²	Weight kg	PN bar	HK galvanised	HK stainl.steel
50	2	37	70.5	83	0.18	20	101 0201	194 0201
76	3	38	100.5	116.5	0.45	12	103 0301	199 0201
89	3 1/2	57	120	137	0.75	20	104 0201	196 0201
108	4 1/4	47	145	167	1.15	12	105 0201	195 0201
133	5 1/4	47	161	191	1.20	12	110 0201	192 0201
159	6 1/4	38	180.5	212	1.90	12	107 0201	197 0201
194	7 5/8	80	234	267	3.50	12*	108 0201	198 0201

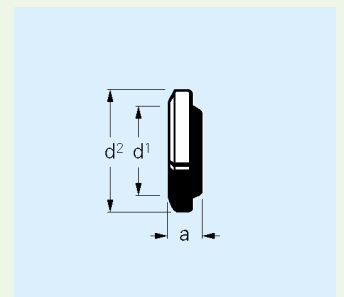

Genuine BAUER HK End Ball S9

Dimension HK	inch	a	d	d ¹	d ²	Weight kg	PN bar	HK galvanised
50	2	54	49.5	52	70	0.13	20	100 6955
76	3	73.5	76	78	97.5	0.26	12	100 7052
89	3 1/2	87	89	90	119.5	0.37	20	100 7055
108	4 1/4	104.5	108	111	144	0.69	12	100 7057
133	5 1/4	96.5	133	135	159.5	0.81	12	100 7054
159	6 1/4	119	159	154	179.5	1.29	12	100 7056
194	7 5/8	127	194	200	230	1.90	12*	100 7053

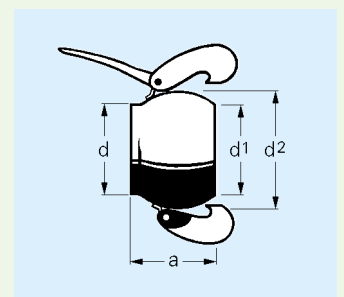

Genuine BAUER Lever Closure Ring S2 required in addition!

Genuine BAUER HK Bend 90° S11

Dimension HK	inch	a	b	c	Gew. kg	PN bar	HK galvanised	HK stainl.steel
50	2	89	111.5	80	1.00	20	101 1101	
76	3	129.5	167.5	85	2.30	12	109 1101	
89	3 1/2	165.5	200	116	3.40	20	104 1101	
108	4 1/4	198	246	114	5.20	12	105 1101	
133	5 1/4	238	276	141	8.30	12	110 1101	
159	6 1/4	250	315	157	11.20	12	107 1101	
194	7 5/8	335	381	186	12.90	12*	108 1101	198 1101

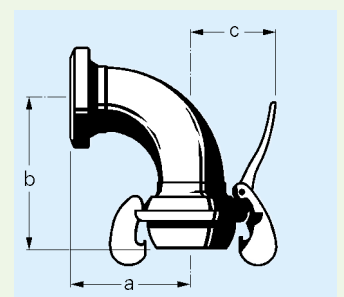

HK COUPLING – The Genuine

Genuine BAUER HK Bend 60° S12

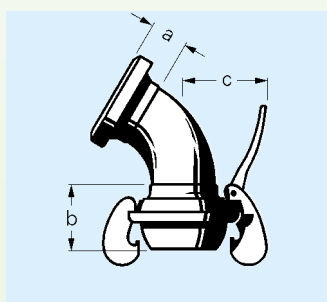

Dimension HK	inch	a	b	c	Weight kg	PN bar	HK galvanised	HK stainl.steel
50	2	33.6	54,5	80	0.95	20	101 1201	
76	3	36	74	85	2.25	12	109 1201	
89	3 1/2	52.5	87	116	3.15	20	104 1201	
108	4 1/4	57	105	114	5.00	12	105 1201	
133	5 1/4	59	96	141	7.45	12	110 1201	
159	6 1/4	48.5	99	157	10.50	12	107 1201	
194	7 5/8	78	106	186	12.60	12*	108 1201	

Genuine BAUER HK "S" Bend S18

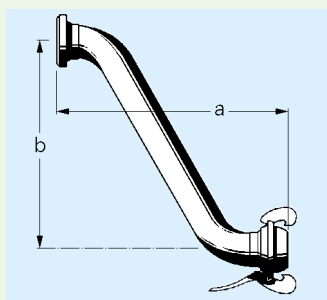

Dimension HK	inch	a	b	Weight kg	PN bar	HK galvanised
76	3	792	956	4.30	12	109 1501
89	3 1/2	817	957	5.65	20	104 1501
108	4 1/4	1007	1219	12.80	12	105 1501
133	5 1/4	1510	2060	25.65	12	110 1501
159	6 1/4	1550	2083	28.00	12	107 1501
194	7 5/8	1710	2130	32.80	12*	108 1501

Genuine BAUER HK Flanged Bend 90° with ball S19

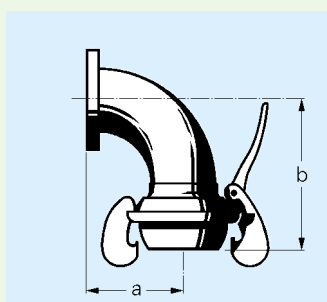

Dimension HK	inch	a	b	DN	PN	Weight kg	Flange DIN	Flange BS 10	Flange ASA
50	2	77	111.5	50	16		100 7070		
89	3 1/2	113.5	200	80	16		100 7069		
89	3 1/2	113.5	200	3"				100 7637	
108	4 1/4	160	246	100	16		100 7068		
108	4 1/4	160	246	4"				100 7636	100 6819
133	5 1/4	198	276	100	16		100 7419		
159	6 1/4	220	315	100	16		100 7965		
159	6 1/4	220	315	150	16		100 7387		
159	6 1/4	220	315	6"				100 7635	100 6818
194	7 5/8	279	381	200	16		100 7388		
194	7 5/8	279	381	8"					100 6817

Genuine BAUER HK Tee S21

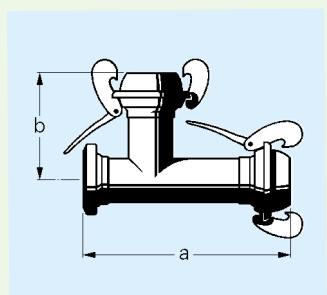

Dimension HK	inch	a	b	Weight kg	PN bar	HK galvanised
50	2	308	154	1.60	20	101 1701
76	3	357	224	3.70	12	109 1701
89	3 1/2	391	205	5.15	20	104 1701
108	4 1/4	453	268	7.55	12	105 1701
133	5 1/4	484	280	10.00	12	110 1701
159	6 1/4	513	299	14.40	12	107 1701
194	7 5/8	747	462	24.40	12*	108 1701



Genuine BAUER HK Inlet Tee S27

Dimension HK	inch	a	b	Weight kg	PN bar	HK galvanised
50	2	378	134	1.50	20	101 1901
76	3	544	192	3.85	12	109 1901
89	3 1/2	510	166	5.30	20	104 1901
108	4 1/4	576	225	7.65	12	105 1901
133	5 1/4	633	250	11.25	12	110 1901
159	6 1/4	678	240	15.20	12	107 1901

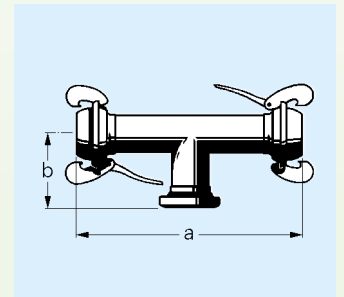

Genuine BAUER HK Hydrant Tees S35/3" and S37/4"

Dimension HK	inch	a	b	c	d	Weight kg	PN bar	HK galvanised
76/3"	3/3	365	240	124	111	3.55	12	241 2301
89/3"	3 1/2/3	393	252	120	111	4.25	20	241 2201
108/3"	4 1/4/3	456	263	148	111	5.65	12	241 2101
133/3"	5 1/4/3	482	279	168	111	7.65	12	241 2001
159/3"	6 1/4/3	517	295	172	111	9.95	12	241 2401
194/3"	7 5/8/3	620	308	203	111	14.40	12	241 1501
108/4"	4 1/4/4	457	320	151	156	6.50	12	242 2401
133/4"	5 1/4/4	488	356	157	156	8.60	12	242 2301
159/4"	6 1/4/4	522	368	174	156	11.80	12	242 2001
194/4"	7 5/8/4	620	390	205	156	20.40	12*	242 2101

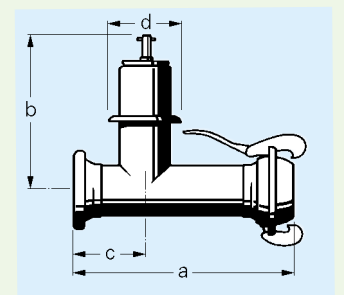

Genuine BAUER HK Connecting Bend with valve spindle S36/3", S38/4", S38 U/4" and S39/5"

Dimension HK	inch	a max.	b	c max.	d	Weight kg	PN bar	HK galvanised
76/3"	3/3	288	171	158	107	3.95	12	241 0200
89/3"	3 1/2/3	288	231	158	107	4.60	20	241 0300
89/4"	3 1/2/4	365	250	186	153	4.20	20	242 0300
108/4"	4 1/4/4	365	207	186	146	5.40	12	242 0200
89/U4"	3 1/2/U4	580	190	190	345	6.20	20	242 5020
108/U4"	4 1/4/U4	580	207	190	345	7.90	12	242 5000
133/5"	5 1/4/5	472	325	246	188	11.00	12	243 0200

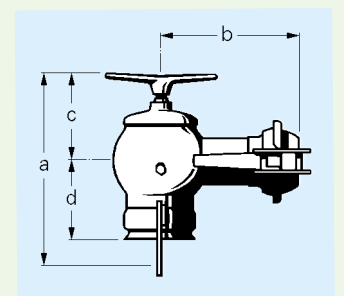

Genuine BAUER HK Brass Gate Valve S63

Dimension HK	inch	a	b	R"	Weight kg	PN bar	HK galvanised
50	2	247	147	2	2.90	20	211 0051
76	3	295	179	2 1/2	4.90	12	211 0052
89	3 1/2	345	200	3	6.40	20	211 0053
108	4 1/4	400	240	4	9.35	12	211 0054
133	5 1/4	455	312	5	17.35	12	211 0057
159	6 1/4	525	360	6	18.65	12	211 0056

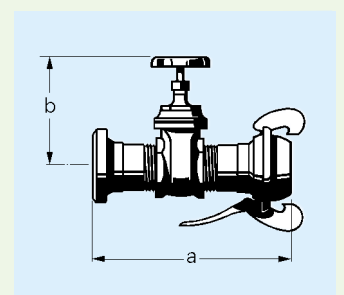

HK COUPLING – The Genuine

Genuine BAUER HK Flanged Connection with ball S70

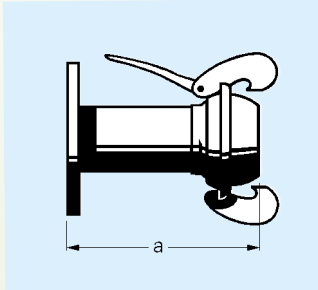

Dimension		a	DN	Weight kg	Flange DIN HK	Flange BS 10	Flange ASA verzinkt
50	2	179	50/2"	2.85	101 2500	100 7106	100 6971
76	3	232	65/3"	4.60	109 2500		100 6970
89	3 1/2	250	80/3"	5.90	104 2500	100 7627	
108	4 1/4	293	100/4"	7.70	105 2500	100 7626	100 6987
133	5 1/4	315	125/5"	10.40	110 2500		
159	6 1/4	334	150/6"	13.60	107 2500	100 7625	100 7005
194	7 5/8	381	200/8"	21.15	108 2500	100 7322	100 7003

Genuine BAUER HK Flanged Connection with socket S73

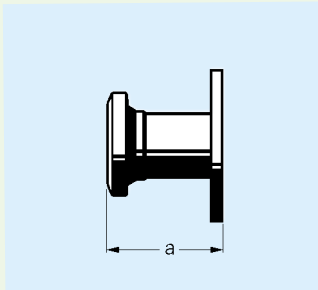

Dimension HK inch		a	DN	Weight kg	Flange DIN	Flange BS 10	Flange ASA galvanised
50	2	110	50/2"	2.35	101 2301	100 7107	100 6969
76	3	125	65/3"	3.40	109 2301		100 6968
89	3 1/2	125	80/3"	4.35	104 2301	100 7630	
108	4 1/4	150	100/4"	5.30	105 2301	100 7629	100 6986
133	5 1/4	150	125/5"	7.70	110 2301		
159	6 1/4	143	150/6"	8.65	107 2301	100 7628	100 7004
194	7 5/8	187	200/8"	14.85	108 2301	100 7321	100 7002

Genuine BAUER HK Reducer S81

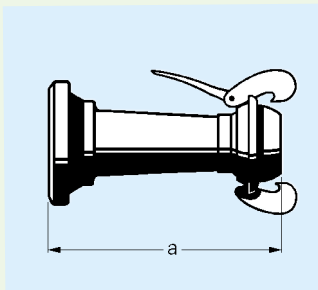

Dimension HK inch		a	Weight kg	PN bar	HK galvanised
76/50	3/2	217	1.10	12	103 2701
89/50	3 1/2/2	280	2.00	20	100 9240
89/76	3 1/2/3	286	2.20	12	104 2711
102/76	4/3	285	2.50	12	152 2711
102/89	4/3 1/2	294	3.00	12	152 2701
108/76	4 1/4/3	290	2.80	12	105 2711
108/89	4 1/4/3 1/2	304	3.20	12	105 2701
108/102	4 1/4/4	336	4.10	12	105 2716
133/76	5 1/4/3	340	4.30	12	100 7851
133/102	5 1/4/4	328	4.55	12	110 2711
133/108	5 1/4/4 1/4	357	4.75	12	110 2701
159/108	6 1/4/4 1/4	345	4.75	12	106 2701
159/133	6 1/4/5 1/4	360	6.50	12	107 2701
194/159	7 5/8/6 1/4	366	10.50	12	108 2701

Genuine BAUER HK Enlarger S82

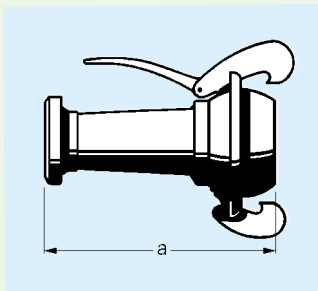

Dimension HK inch		a	Weight kg	PN bar	HK galvanised
50/76	2/3	230	1.80	12	101 1601
50/89	2/3 1/2	280	2.00	20	100 9649
76/89	3/3 1/2	295	2.60	12	109 1601
76/102	3/4	300	3.00	12	109 1621
76/108	3/4 1/4	310	3.50	12	100 9160
76/133	3/5	455	5.00	12	100 7290
89/102	3 1/2/4	304	3.35	12	104 1611
89/108	3 1/2/4 1/4	329	3.75	12	104 1601
102/108	4/4 1/4	342	4.70	12	152 1611
102/133	4/5 1/4	320	5.40	12	152 1601
108/133	4 1/4/5 1/4	367	5.65	12	105 6701
108/159	4 1/4/6 1/4	370	7.13	12	105 16 01
133/159	5 1/4/6 1/4	394	7.65	12	110 1601
159/194	6 1/4/7 5/8	356	11.00	12	107 1601

= part number – non-stated references on request!



HK Hose Connection

Genuine BAUER HK hose connectors are recommended and used by leading international hose manufacturers

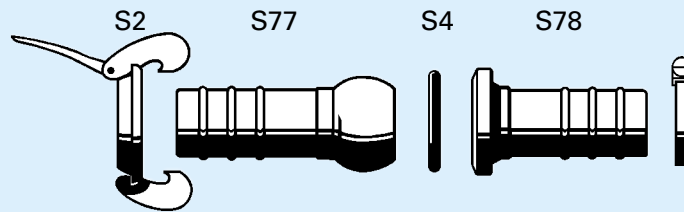

Genuine BAUER HK Hose Coupling with ball S77

Hose clamp

Dimension HK	inch	a	b	d	Weight kg (HK)	HK galvanised	HK stain.steel	mm from - to	
50	2	200	145	50	0.38	101 1011	194 1011	52-55	062 5149
70	3	235	155	69	0.72	103 1011		74-79	062 5089
70	3	225	145	63	0.70	100 7759		74-79	062 5089
76	3	229	145	74,6	0.82	109 1011		80-85	062 5172
89	3 1/2	242	155	74,6	1.20	104 1021	196 1011	80-85	062 5172
89	3 1/2	242	155	89	1.60	104 1011		92-97	062 5082
108	4 1/4	263	155	74,6	1.60	100 9013		80-85	062 5172
108	4 1/4	263	155	89	1.65	100 9015		92-97	062 5082
108	4 1/4	313	208	100	1.70	105 1011	195 1011	104-112	062 5176
108	4 1/4	313	208	108	1.80	105 1021		113-121	062 5065
133	5 1/4	308	208	100	2.10	100 7078		104-112	062 5176
133	5 1/4	305	208	125	2.25	110 1011		131-139	062 5087
159	6 1/4	350	232	150	3.35	107 1011	197 1011	149-161	062 5086
194	7 5/8	397	270	200	3.90	108 1011	198 1011	201-213	062 5067

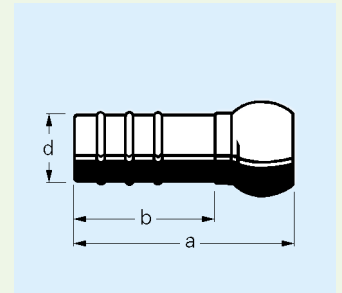

Genuine BAUER HK Hose Coupling with socket S78

Hose clamp

Dimension HK	inch	a	b	d	Weight kg (HK)	HK galvanised	HK stain.steel	mm from - to	
50	2	179	145	50	0.40	101 0711	194 0711	52-55	062 5149
70	3	197	155	69	0.70	103 0711		74-79	062 5089
70	3	190	145	63	0.70	100 7664		74-79	062 5089
76	3	194	155	74,6	0.80	109 0711		80-85	062 5172
89	3 1/2	204	155	74,6	1.25	104 0721	196 0711	80-85	062 5172
89	3 1/2	209	155	89	1.68	104 0711		92-97	062 5082
108	4 1/4	215	155	74,6	1.45	100 9229		80-85	062 5172
108	4 1/4	215	155	89	1.50	100 9014		92-97	062 5082
108	4 1/4	266	208	100	1.70	105 0711		104-112	062 5176
108	4 1/4	266	208	108	1.80	105 0721	195 0711	113-121	062 5065
133	5 1/4	268	208	100	2.30	100 7077		104-112	062 5176
133	5 1/4	268	208	125	2.40	110 0711		131-139	062 5087
159	6 1/4	282	232	150	3.30	107 0711	197 0711	149-161	062 5086
194	7 5/8	346	270	200	4.30	108 0711	198 0711	201-213	062 5067

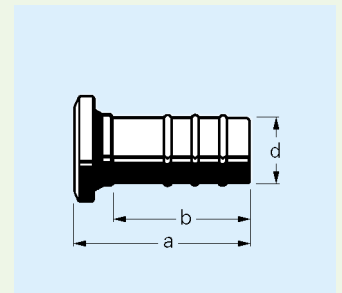

HK COUPLING – The Genuine

The optimum joint

BAUER HK ball and socket with thread, an excellent connection to existing installations

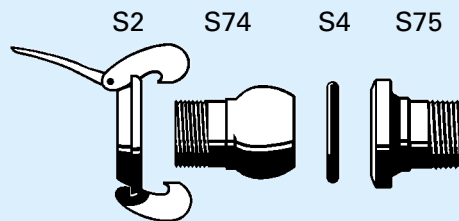

Genuine BAUER HK Ball with thread S74

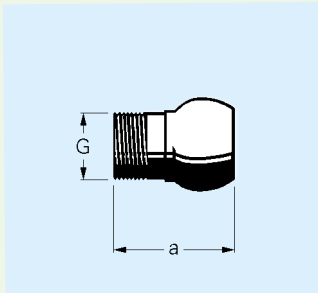

Dimension HK	inch	a	G"	Weight kg	Thread ISO 228 galvanised	Thread NPT galvanised	Thread BSP galvanised
50	2	112	1 1/2	0.35	100 0186	100 0191	100 7590
50	2	112	2	0.40	101 0801	101 0811	100 7632
76	3	149	2 1/2	0.70	103 0801	103 0811	
76	3	170	3	1.00	100 8979	109 0820	
89	3 1/2	170	2 1/2	1.00	104 3601		100 7631
89	3 1/2	177	3	1.00	104 0801	104 0811	
108	4 1/4	180	3	1.30	105 3600		100 7218
108	4 1/4	195	4	1.75	105 0801	105 0811	
133	5 1/4	175	4	1.80	110 3601		
133	5 1/4	215	5	2.60	110 0801		
159	6 1/4	212	5	3.00	106 0801		
159	6 1/4	260	6	4.10	107 0801	107 0811	
194	7 5/8	310	8	5.00		108 0810	

ISO 228 corresponds to BSP

Genuine BAUER HK Socket with thread S75

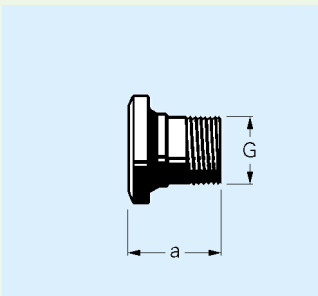

Dimension HK	inch	a	G"	Weight kg	Thread ISO 228 galvanised	Thread NPT galvanised	Thread BSP galvanised
50	2	75	1 1/2	0.30	100 6945		100 7581
50	2	93	2	0.40	101 0501	101 0511	100 7634
76	3	112	2 1/2	0.75	103 0501	109 0511	
76	3	140	3	1.10		109 0521	
89	3 1/2						
89	3 1/2	135	3	1.20	104 0501	104 0511	100 7633
108	4 1/4	148	3	1.50			100 7153
108	4 1/4	148	4	1.75	105 0501	105 0511	
133	5 1/4						
133	5 1/4	180	5	2.95	110 0501		
159	6 1/4	190	5	3.80	107 0513		
159	6 1/4	195	6	4,10	107 0501	107 0511	
194	7 5/8	255	8	5.20		108 0511	

ISO 228 corresponds to BSP



BAUER

Conversion table

1 mm	= 0.0394 Inches	220 Imp.Gallons	= 1 m ³	= 1000 Liter
1 Inch	= 25.4 mm	264 US Gallons	= 1 m ³	= 1000 Liter
1 m = 39.37 Inches	= 3.28 Feet	1 Cu.Ft.	= 6.23 Imp.Gallons	= 7.48 US Gallons = 28.3 Liter
1 Foot	= 304.8 mm	1 Cu.Ft. Water	= 62.288 Lbs	= 28.26 kg
1 Imp. Gallon	= 4.546 Liter	1 Lb	= 0.454 kg	1 kg = 2.204 Lbs
1 US Gallon	= 3.785 Liter	1 bar	= 0.986 atm	= 14.5 psi = 1.0197 kg/m ²
1 Imp.Gallon/min	= 0.272 m ³ /h	1 atm	= 14.7 psi	= 1.013 bar
1 US Gallon/min	= 0.227 m ³ /h	1 m ³ /h	= 367 Imp.Gallons/min	= 4.4 US Gallons/min

Original BAUER pipes and accessories cover almost any requirement in this field of application. Our pipes and fittings are galvanized according to DIN 50976. Fast and easy to install. With up to 30° articulation on the coupling joint the pipes adjust easily to the site and ground conditions

without loss of suction and pressure integrity. The sealing ring is captive in the coupling socket. HK couplings are coupled and uncoupled with a few simple hand movements and require no special skills or tools.

Friction loss with water

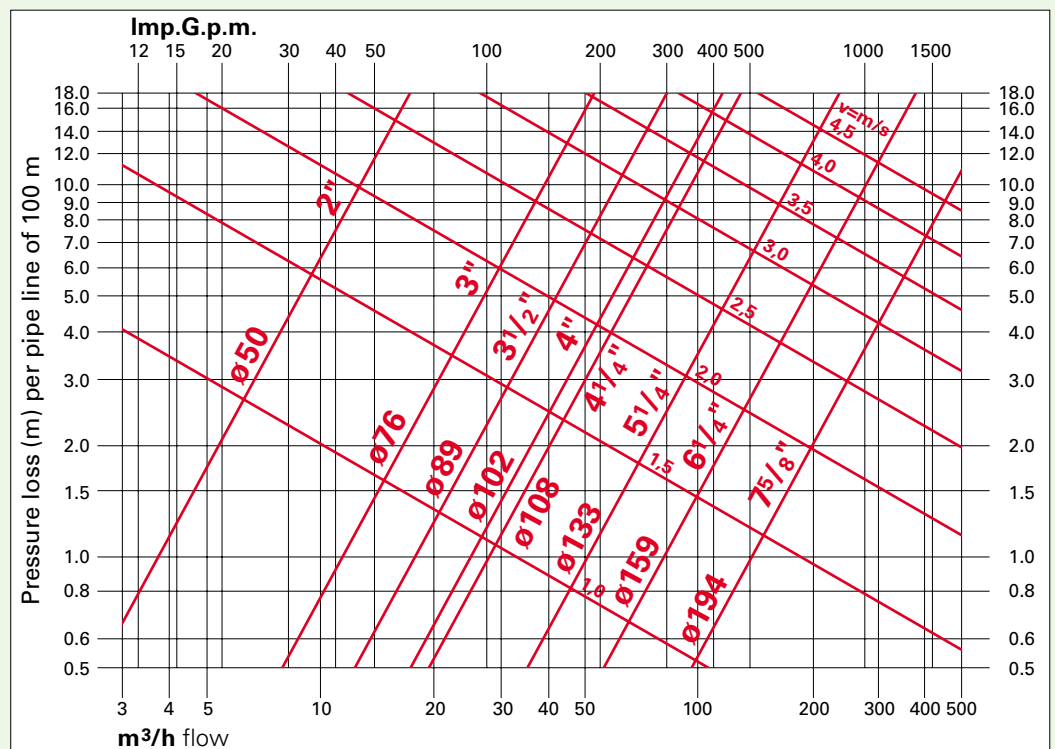

Characteristics for compressed air on request!



BAUER

FOR A GREEN WORLD



Top quality "in house" production

Since its development by Rudolf BAUER over 50 years ago, several attempts have been made to copy the BAUER HK quick coupling but none of the imitations ever reached the quality and durability of the Original.

This high BAUER quality level results from the uncompromising use of high-grade materials and the company's own production and quality control on pipe mills specifically designed for this purpose. Millions of BAUER HK quick-coupling pipes prove their value in tough industrial and agricultural applications throughout global markets.



Your Dealer:

Röhren- und Pumpenwerk BAUER GmbH
8570 Voitsberg, Austria
Phone +43 3142 200-0
Fax +43 3142 200-320 / -340
www.bauer-at.com, sales@bauer-at.com